

## Installation Manual

---

# VicWallpaper VMT

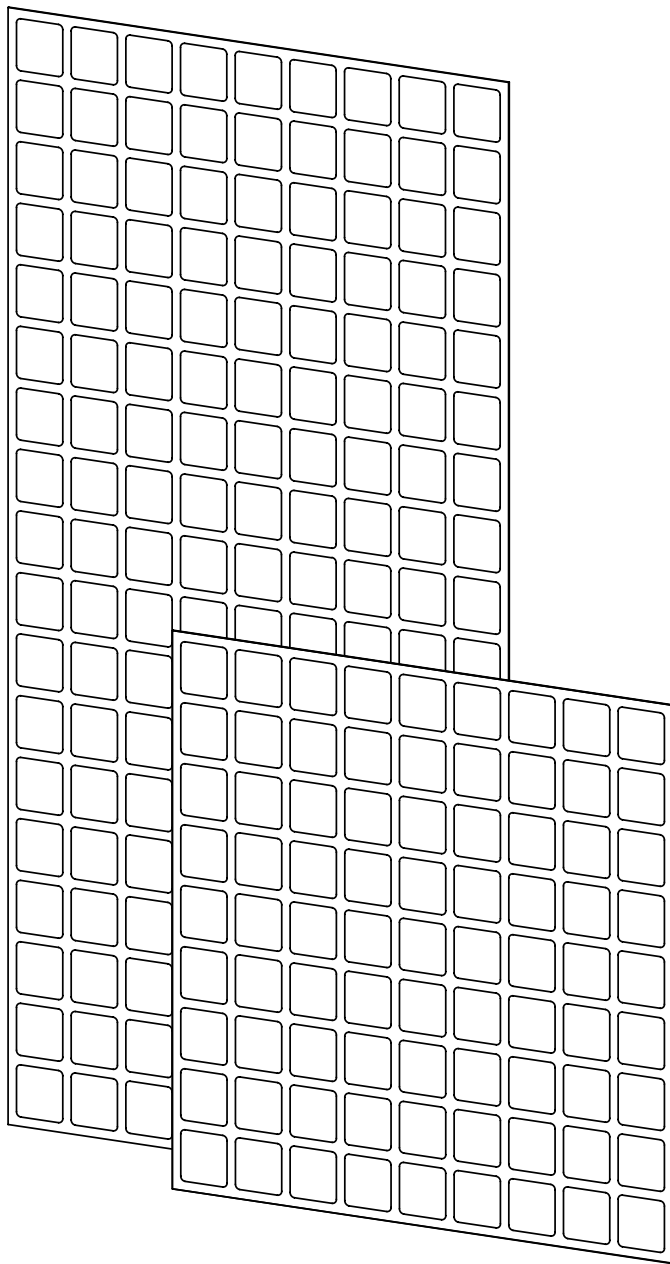

**MATERIAL NEEDED:**

**Included**

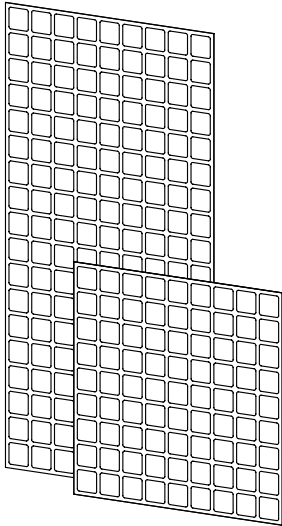

VicWallpaper VMT x8

**Not Included**

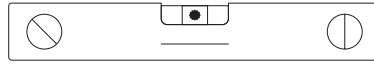

Level

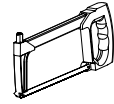

Cutting Tools

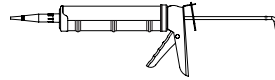

Flexi Glue Ultra

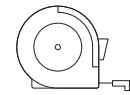

Measuring Tape

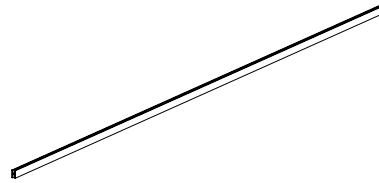

AluFrame VicWallpaper

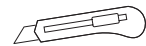

Box Cutter

**AVAILABLE FORMATS:**

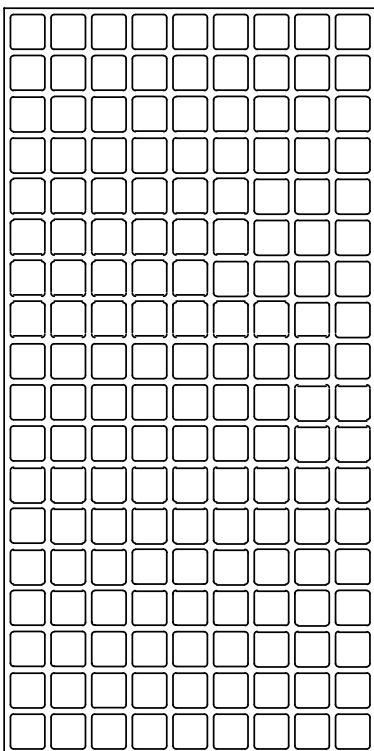

1190 x 595mm

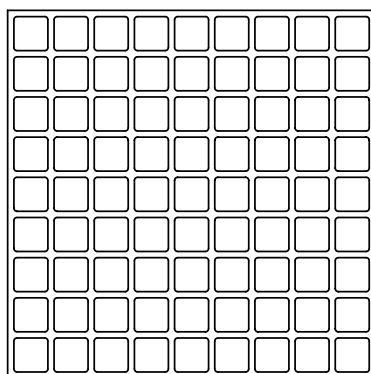

595 x 595mm

\* We recommend the installation of this product with the AluFrame VicWallpaper, sold separately.

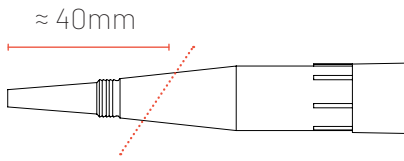

If the nozzle is not already cut, cut it according to the diagram.

1

Apply the glue on the back of the acoustic panel, near the edges, but still in the foam part of the panel (approx. 2"/5 cm from the edge). Do not wait longer than 10 minutes after applying the glue to attach the panel to the wall.

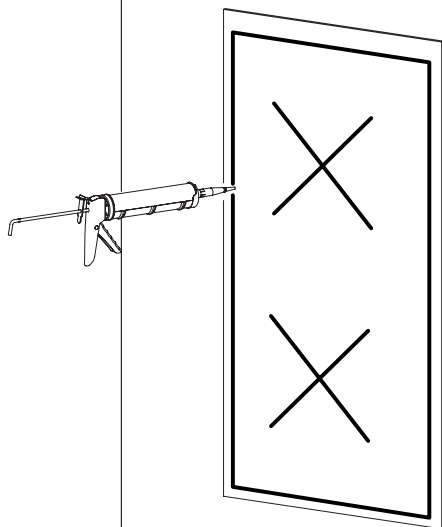

2

Place the panel in the predefined position. Once in the desired place, press firmly against the wall for 15 seconds.

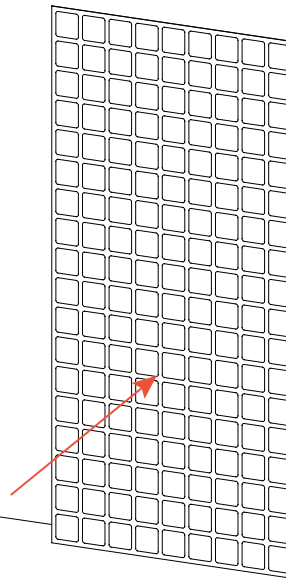

Use the same process to install the panels on the ceiling.

*Always apply the glue in stripes. Do not apply the glue in dots. When applying the glue, position the nozzle tip pre-cutted at 45° angle, so that it applies some pressure on the glue against the back of the panel.*

*For ceiling panel installations, you may need to use ceiling supports to hold the panels in place while the glue dries.*

*To ensure that you maximise the strength of the glue, don't make any adjustments or remove the panel after bonding.*

Wall and ceiling surfaces should be examined prior to installation, ensuring they are clean, smooth, and dry. If you have unpainted gypsum board surfaces, these should be primed with a drywall primer (or another material manufactured especially for the purpose), to equalize the absorption between the gypsum board face paper, joint compound, and skin coating materials. You should then apply the paint, and allow air circulation in order to dry the paint within the time frame specified by the paint manufacturer. Please ensure the paint is dry before installing the acoustic panel. Make sure the room has all the necessary conditions to receive the acoustic panels. After you apply the glue on the back of each acoustic panel, please ensure you hold the acoustic panel against the wall the required time (mentioned above), and ensure it stays fixed in place. This method is also applicable to ceiling installations.

**Do not apply VicWallpaper VMT behind radiators or too close to a heat source.**

3

Cut the AluFrame VicWallpaper to the desired length.

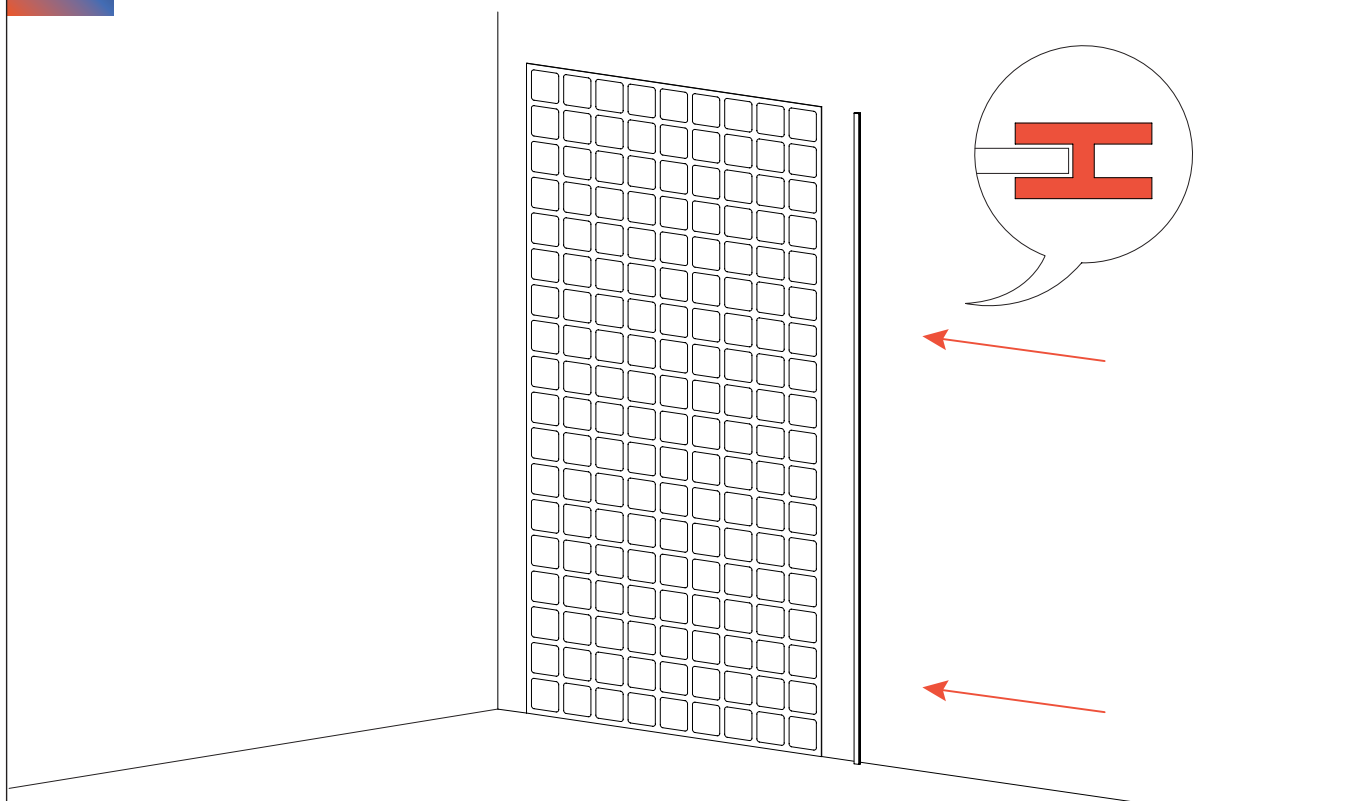

4

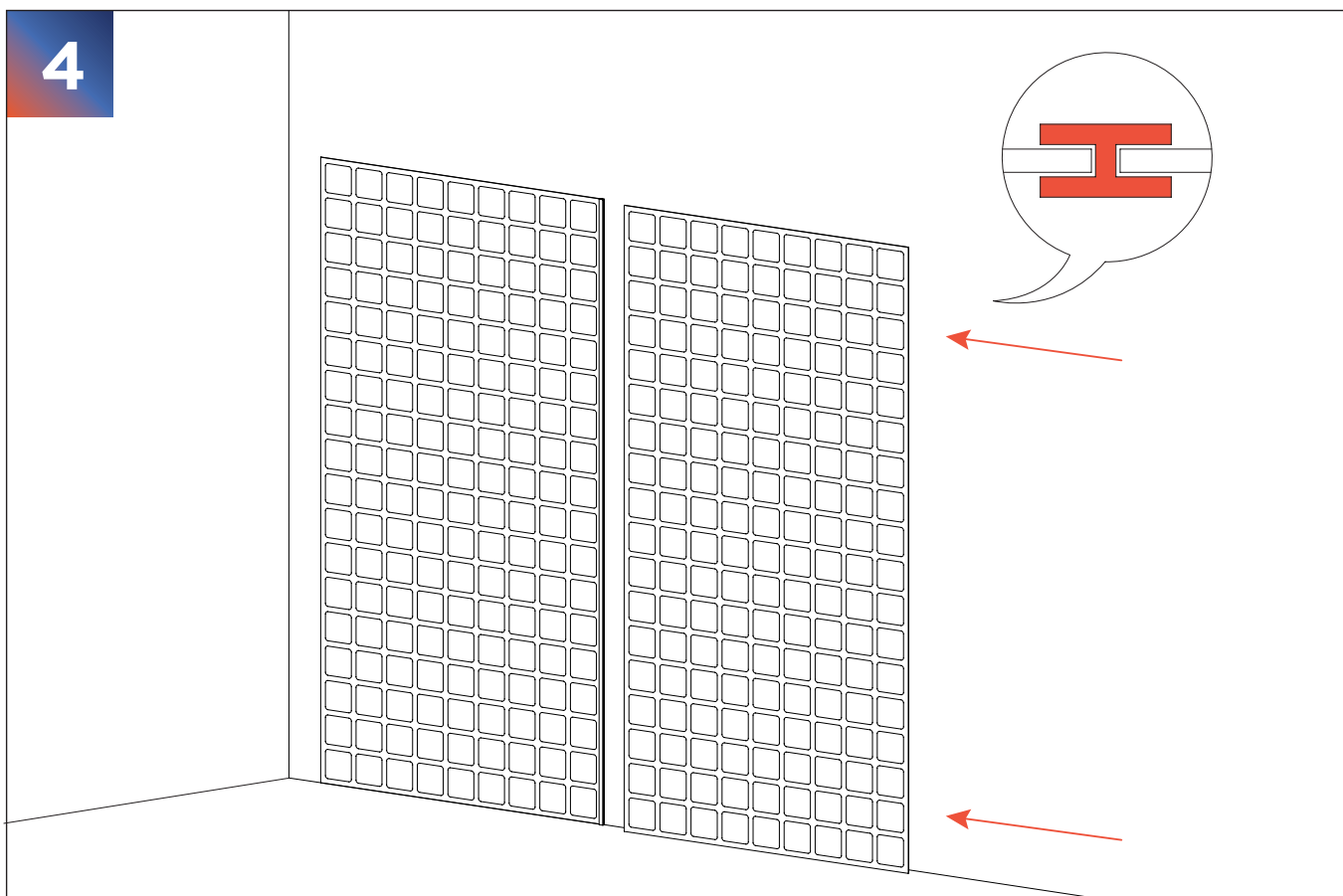

## FULL WALL INSTALLATION

1

Measure wall height in both sides. Take the smallest height.

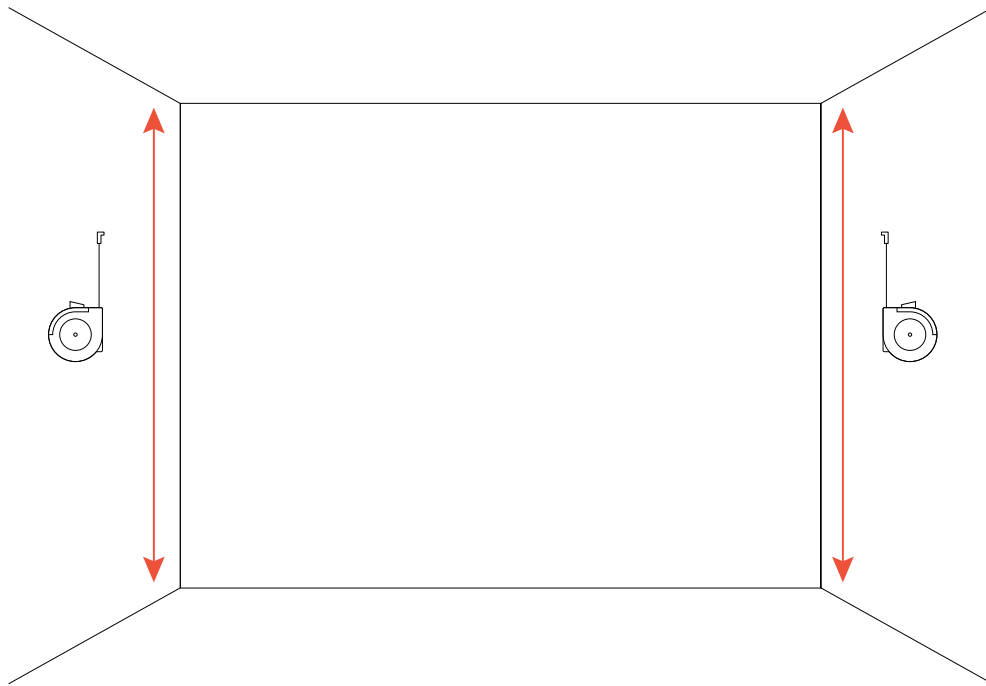

2

Based on the smallest height, calculate if it is necessary to cut one of the panels to fill the entire wall height. Check for continuity between panels before cutting.

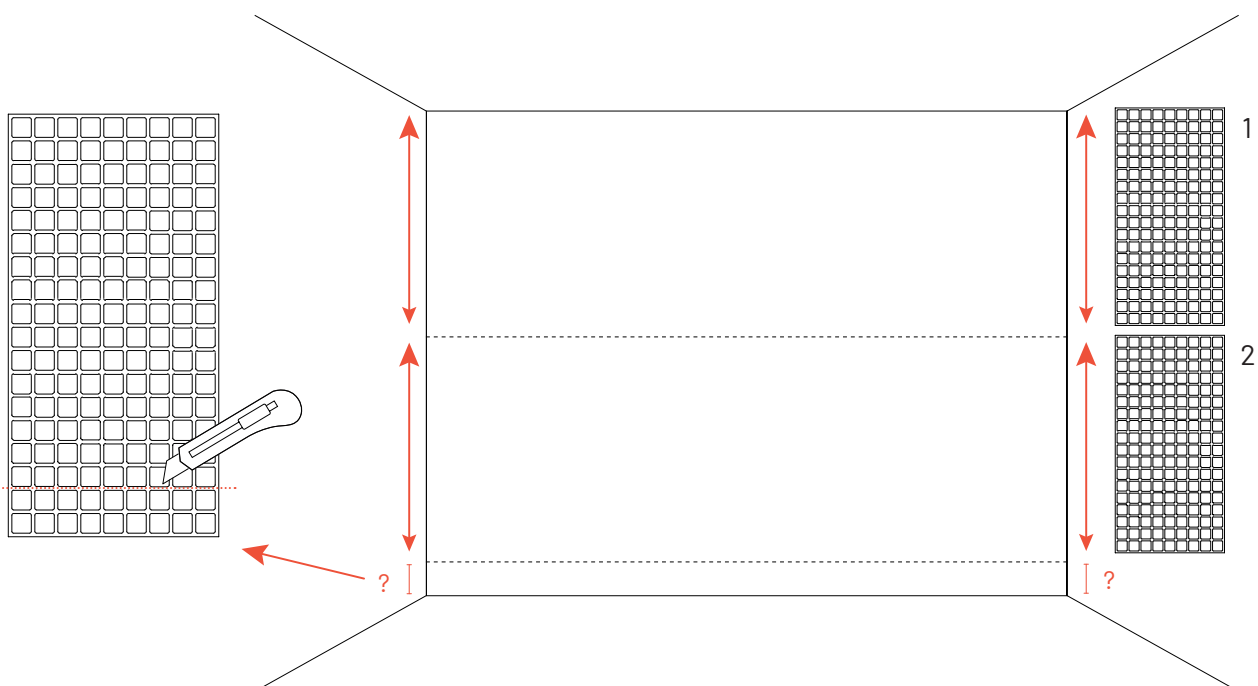



**Head Office:** Unit No.2G, Laxmi Industrial Estate, New Link Road, Andheri (W), Mumbai - 400 053.

**R&D Office:** Survey No. 271/4, New Sr. No. 3099/1, Village - Khattalwada, Malkhet, Near Gram Panchayat  
Malkhet, Taluka - Umbergaon, Dist - Valsad, Gujarat - 396 120.

**Info and Sales:** [info@uniacoustic.com](mailto:info@uniacoustic.com)

[www.uniacoustic.com](http://www.uniacoustic.com)

3

Start the installation from the bottom-right side (If cuted panels are going to be used it is recommended to start with these). Check if panels are leveled before proceeding to next row.

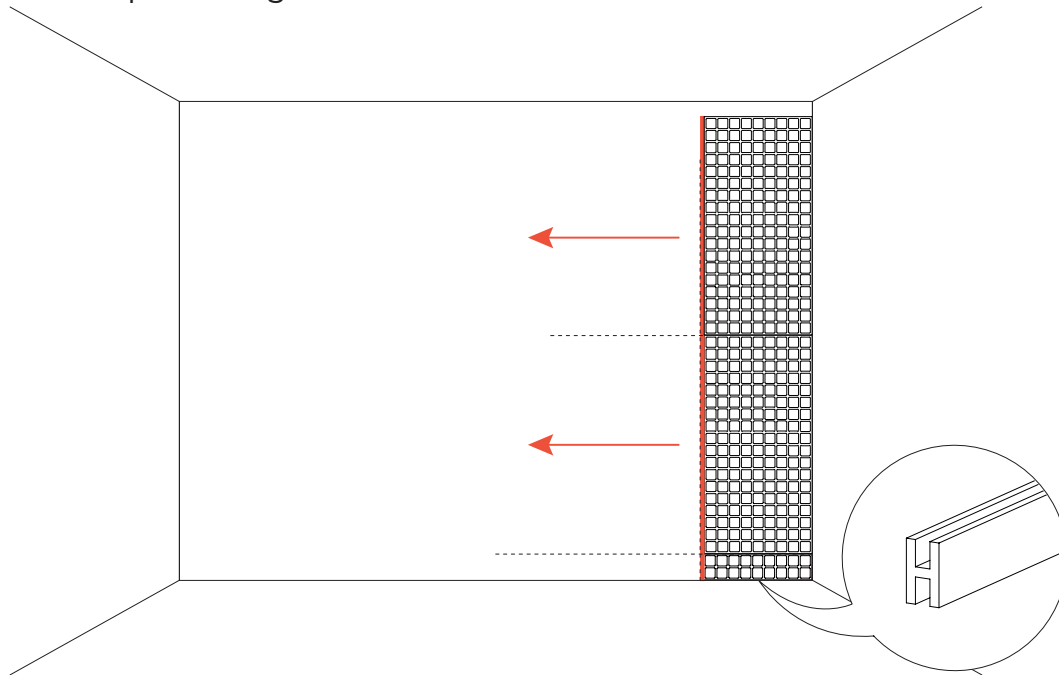

4

After installing the first column, apply the AluFrame VicWallpaper and repeat the process successively.

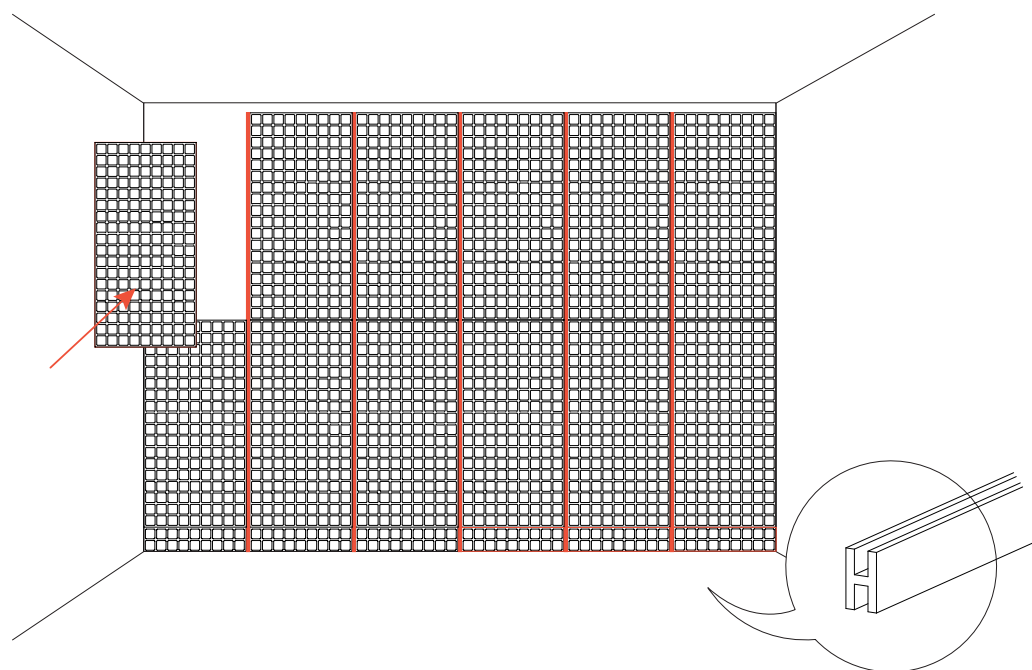

Do not apply VicWallpaper VMT behind radiators or too close to a heat source.