

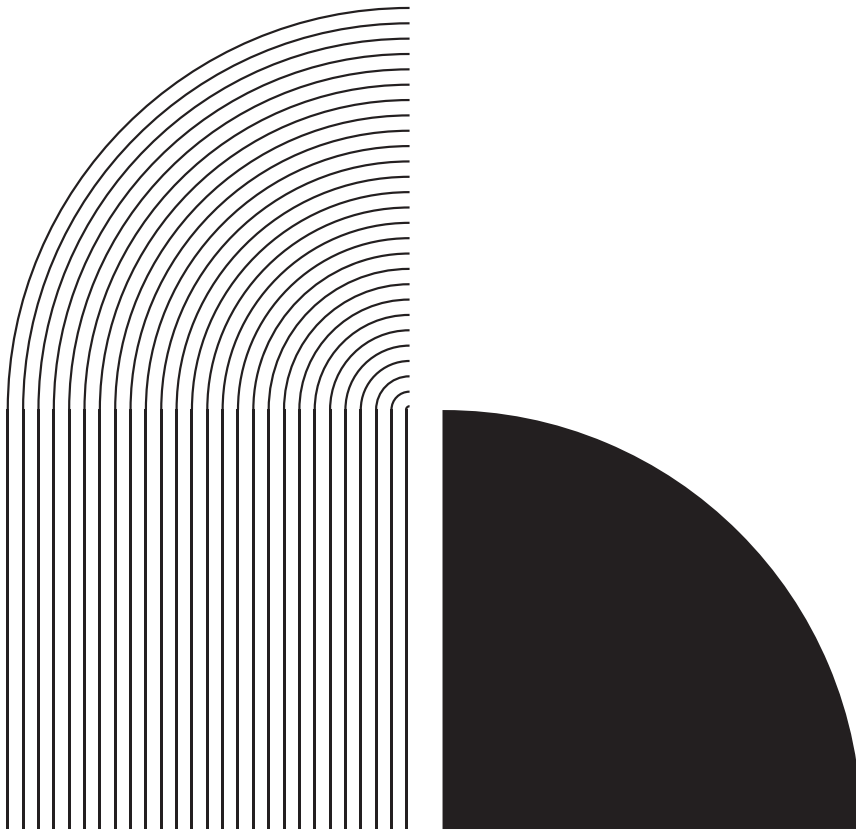

Installation Manual

Uni-VicShape 3D Duo



MATERIAL NEEDED:

Included

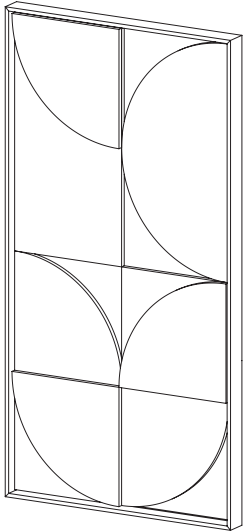

Not Included

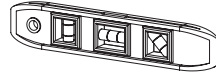

Level

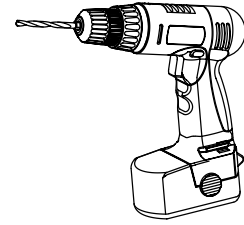

Circular saw

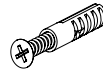

Wall Plugs and Screws

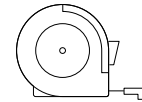

Measuring Tape

1

Before installing the panels, measure the wall where you are going to install them. Depending on the type of wall, you can fix a direct screw or use a wall plug and screw (not provided), to support the VicShape 3D.

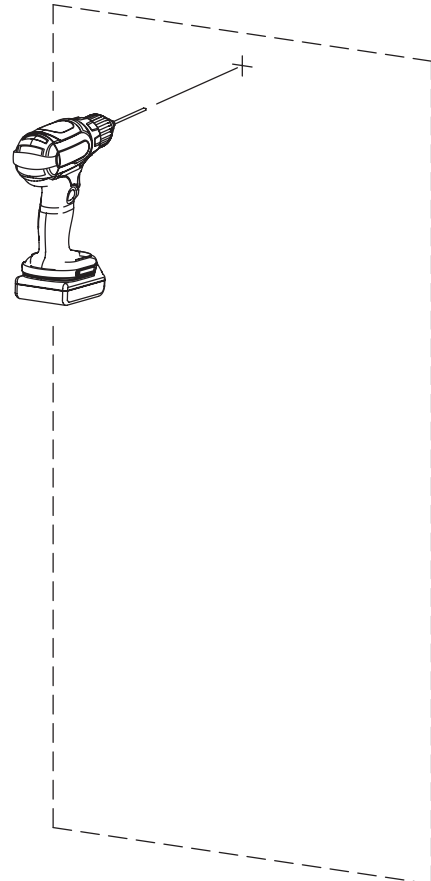

2

Suspend the panel

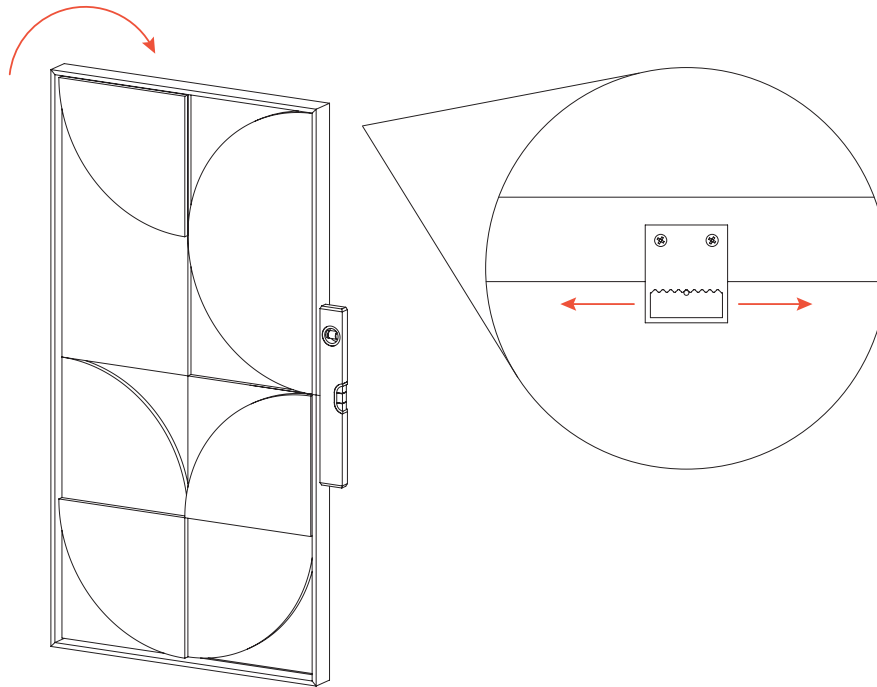

Suggested layout

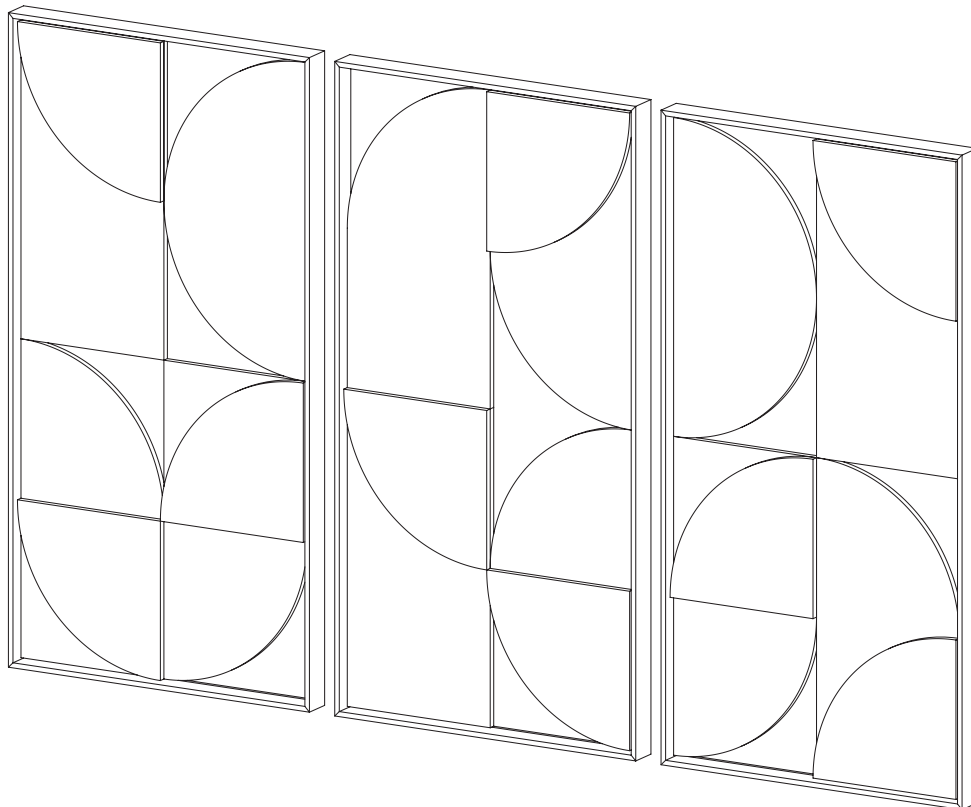

If you choose to install the panel horizontally, unscrew the suspension clip and screw it into the middle of the long side of the frame (580mm from the edge).

The silicone drops should be applied in the lower corners of the panel.



Head Office: Unit No.2G, Laxmi Industrial Estate, New Link Road, Andheri (W), Mumbai - 400 053.

R&D Office: Survey No. 271/4, New Sr. No. 3099/1, Village - Khattalwada, Malkhet, Near Gram Panchayat
Malkhet, Taluka - Umbergaon, Dist - Valsad, Gujarat - 396 120.

Info and Sales: info@uniacoustic.com

www.uniacoustic.com