

ViCloud 3D VMT



ViCloud 3D VMT



DESCRIPTION:

ViCloud VMT 3D is a lightweight acoustic solution designed to hang effortlessly from ceilings. Perfect for spaces with high noise levels, like restaurants, offices, or atriums, it reduces disruptive sounds. Available in various shapes and colors, it's easy to install without professional help.

FEATURES:



Lightweight



Easy to install



Easy to clean
and maintain



High Performance in
medium and high frequencies

AVAILABLE FINISHES:

Colors

| | | | | | |
|---------------|-------|------------|------------|-------|----------------|
| Natural White | Black | Grey | Musk Green | Blue | Bondi Blue |
| Beige | Coral | Light Grey | Moss Green | Brown | Pumpkin Orange |

Shapes

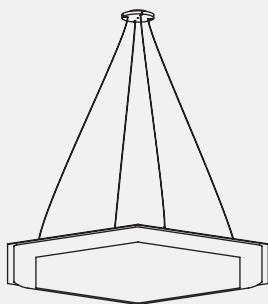

Hexagon



Round

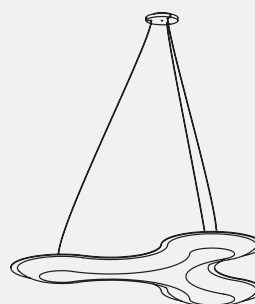

Petal

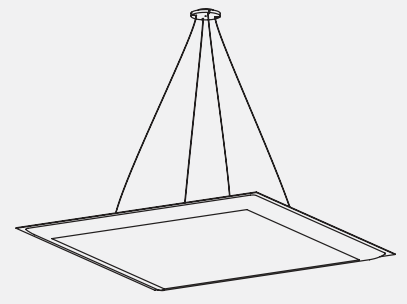

Square

*Color customization available on request subject to MOQ.

Pattern



Nature Tropical



Nature Tropical



Nature Tropical



Natural Woods_Oak



Natural Woods_Ebony



Natural Woods_Black Laurel



Natural Woods_Almond Oak



Natural Stones_Travertino Classico



Natural Stones_Striato Elegante

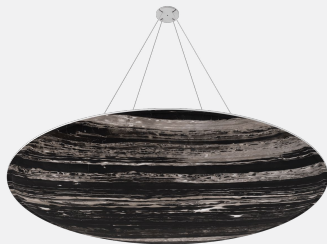

Natural Stones_Port Black



Natural Stones_Patagonia



Natural Stones_Moonlight Grey



Natural Stones_Magic Brown



Natural Stones_Invisible Grey



Natural Stones_Hematite Black



Natural Stones_Grey Stone



Natural Stones_Fusion Wow



Natural Stones_Emperador Dark



Natural Stones_Calacatta Crema



Natural Stones_Calacatta Carrara



Concrete_Pattern 3



Concrete_Pattern 1

TECHNICAL INFORMATION:

Main Info

| | | |
|-----------------------|--|--|
| Dimensions(L x H x W) | Square: 1200 × 1200 × 40 mm Round: ø 1200 × 40 mm | Hexagon: 1200 × 1039 × 40 mm Petal: 1200 × 1095 × 40 mm |
|-----------------------|--|--|

Performance

| | |
|----------------------------|-----------------------------|
| Functionality | Absorption |
| Absorption Frequency Range | Medium and High Frequencies |

Packaging Information

| | |
|------------------|------|
| Units/Box | 4 |
| Box Gross Weight | 15kg |

Installation

| | |
|-------------|--------------------------------|
| Accessories | Mechanical Fixation (included) |
| Place | Ceiling |

Fire Compliance

| |
|--|
| ASTM-E84 Class A BS 476 Part 6 & 7 Class 1 EN-13501 Part 1 C, s2, d0 |
|--|

Disclaimers:

Color combinations are available upon request, subject to minimum order quantity (MOQ).

Please note that the dimensions of these panels have a tolerance of +/- 2mm.

Do not apply these panels behind radiators or too close to a heat source.

A slight color variation may occur between different batches.

The product images used are illustrative and may differ from the actual product.

ACOUSTIC PERFORMANCE:

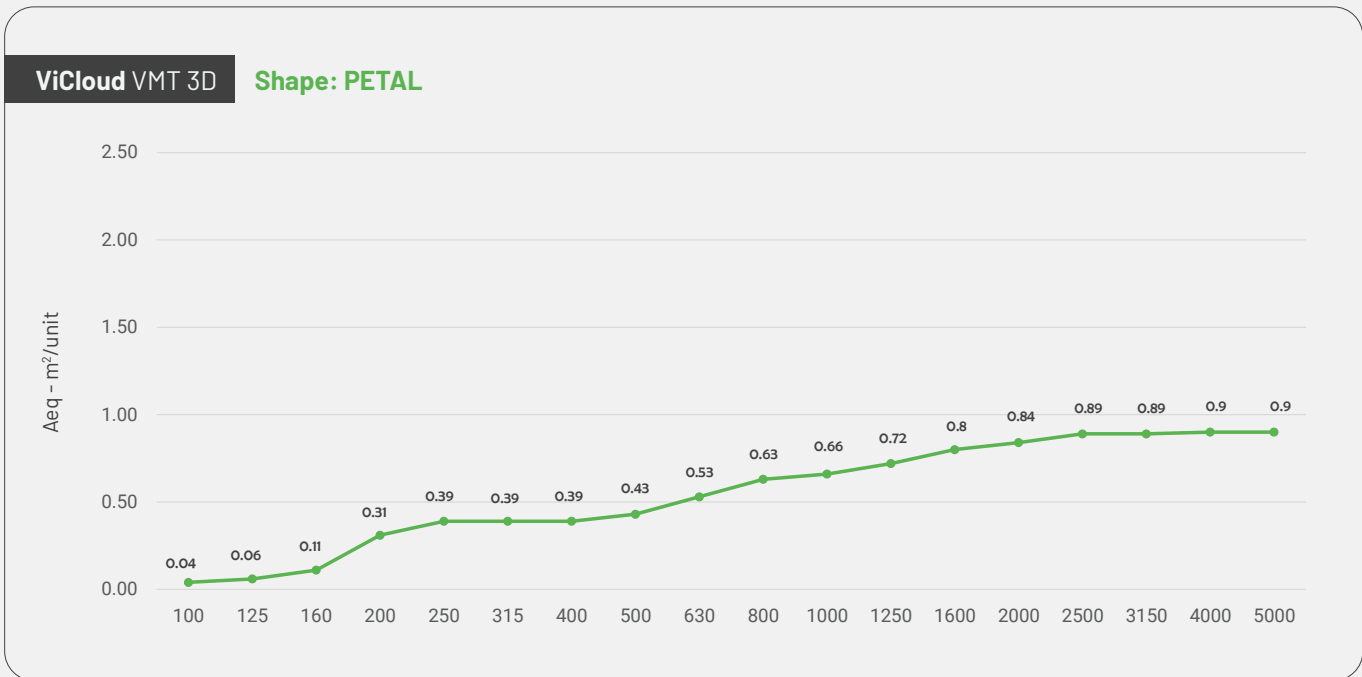
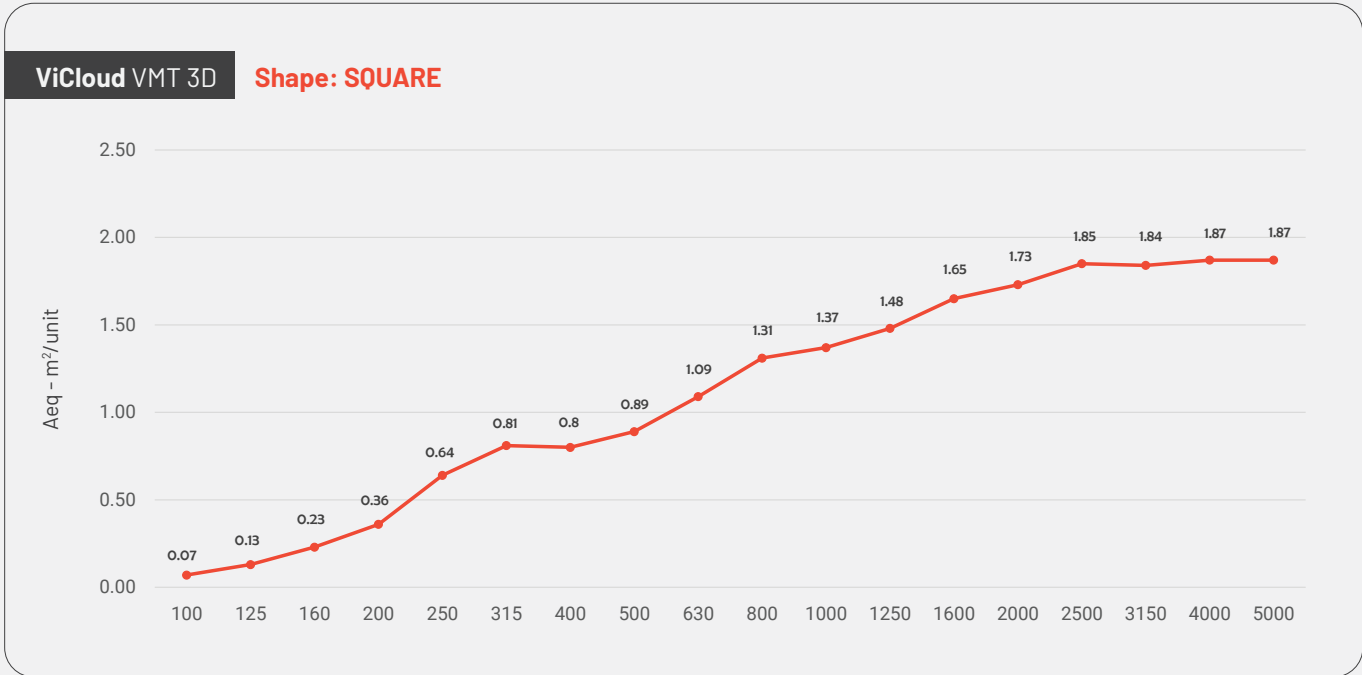

ACOUSTIC PERFORMANCE:

ViCloud VMT 3D Shape: **HEXAGON**

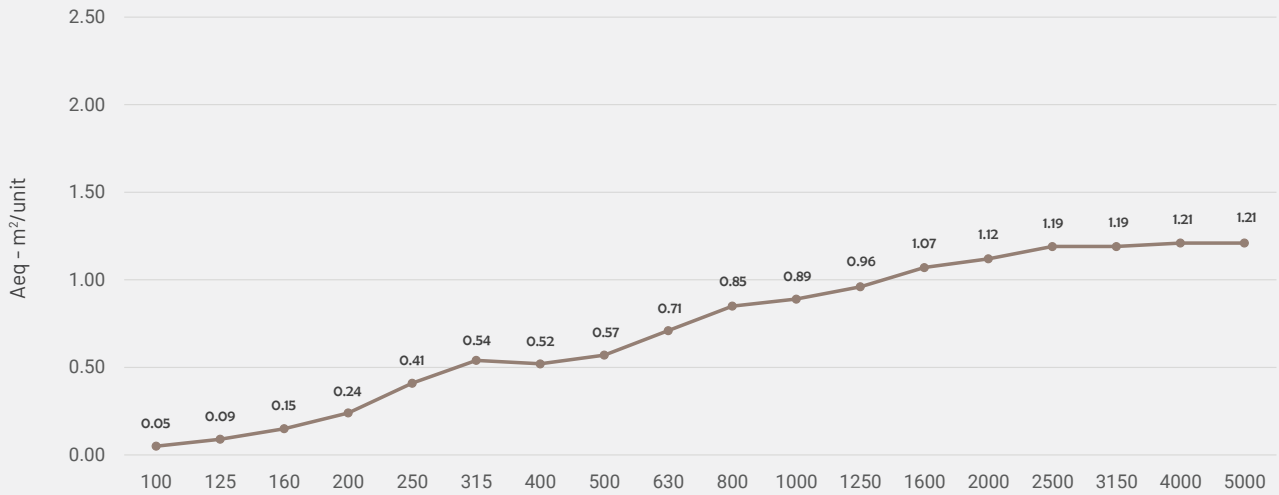

ViCloud VMT 3D Shape: **ROUND**

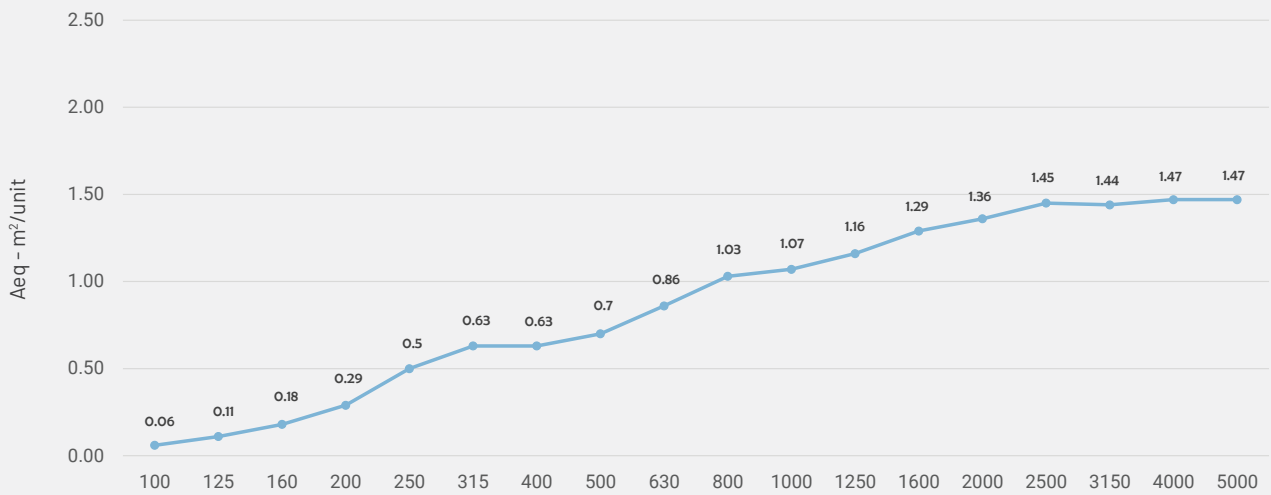

ViCloud VMT 3D



ViCloud VMT 3D

